



# HOT MAX-M

Mibrasa oven with heated holding drawers and top heated cupboard



## TECHNICAL INFORMATION

Reference	HMB HOT AC 110
Fire up time <sup>1</sup>	45 min
Cooking temperature	250 - 350 °C
Initial charcoal load <sup>1</sup>	15 kg
Production*	100 kg/h
Charcoal load duration <sup>2</sup>	8 h
Equivalent power*	5 kW
Exhaust rate	3200 m <sup>3</sup> /h
Net weight <sup>3</sup>	757 kg
Crated weight	897 kg
Crate dimensions (WxDxH)	1) 1100 x 1100 x 1350 mm 2) 1100 x 1100 x 2050 mm

\*Approximate data

1. Consult instruction manual
2. Will vary depending on quality of charcoal
3. Weight with accessories included

## FEATURES

### OUR CHARCOAL OVENS WITH **hot** HEATED HOLDING-DRAWERS

The Mibrasa® oven is a closed grill designed and engineered in our workshops. Made from the best quality steel by expert hands, our grills are designed to satisfy even the most demanding chefs.

The technical specifications allow the user to accurately control the air flow through the grill, changing the intensity of the embers. This is an extremely efficient way of cooking and cuts down the amount of charcoal needed.

With the HOT series take full control by optimizing the residual-heat from the Mibrasa® oven to hold ingredients in three temperature zones on the unit. The seamless lineal design makes the Mibrasa® HOT the most comprehensive charcoal oven station for any chef that prioritizes an effective and cost-efficient kitchen.

### PAX PER SERVICE\*



### GRILL DIMENSIONS

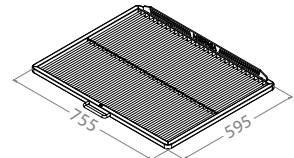

## INCLUDED ACCESSORIES

- Grill [GT110]
- Mibrasa tongs [TG]
- Ash shovel [PALA]
- Ember poker [PK110]
- Grill brush [CEP]
- Heating rack top cabinet [SBAC]
- Gastronorms [1x GN1/2, 1x GN1/1]

## RECOMMENDED ACCESSORIES

- Firebreak-dissipating filter [FB-DF]
- Extra grill [GT110]
- Removable grease collector [REG3/4]
- Casters [WINOX]
- Consult catalogue for kitchenware and grillware

QUALITY GUARANTEE



Rev. 9/23

Mibrasa® Charcoal Ovens S.L

C/Joan Rovira i Bastons, 26

17230 Palamós - Spain

+34 972 601 942 - mibrasa@mibrasa.com

www.mibrasa.com

Front view

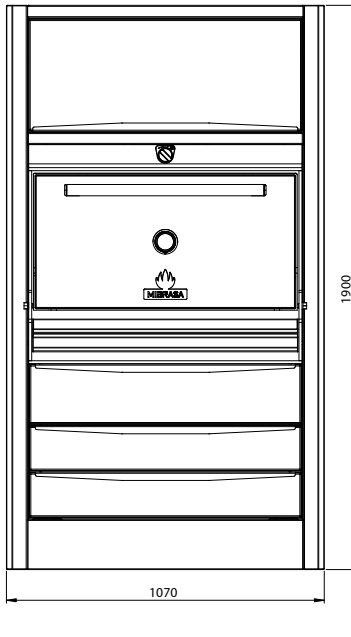

Side view

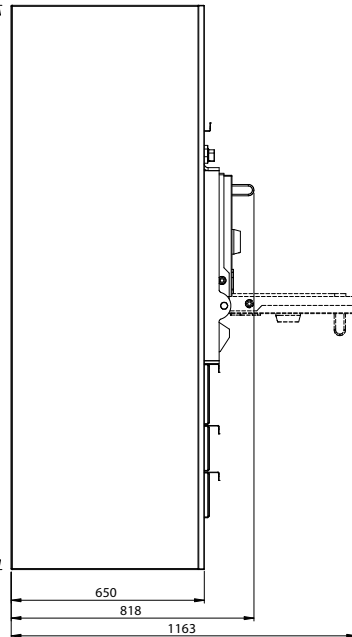

Option 1

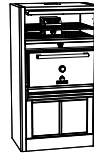

Option 2

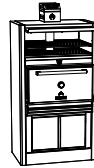

Dimensions in mm  
Revit drawings available on request at [mibrasa@mibrasa.com](mailto:mibrasa@mibrasa.com)

Total height option 2: 2141 mm

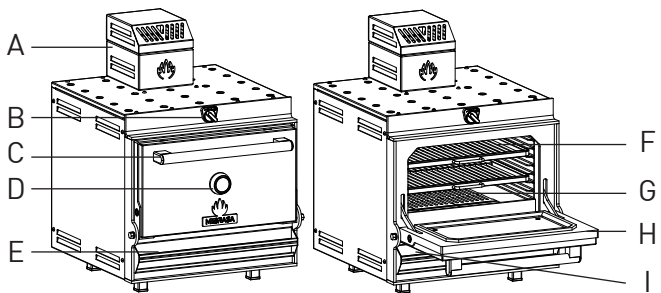

A	Firebreak-dissipating filter
B	Upper damper
C	Door handle
D	Thermometer
E	Lower damper/ash collector
F	Cooking grills
G	Charcoal grids
H	Door
I	Grease collector

## GASTRONORM CAPACITY

Compatible with Mibrasa GN

### HOT DRAWER (x3)

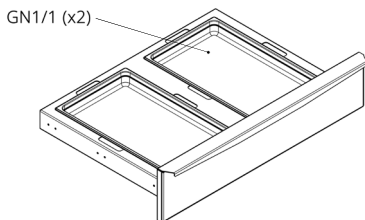

Residual temperatures of the drawers between 55°C and 90°C based on oven working at 300°C. Maximum gastronorm height 6 cm.

### HEATING RACK (x2)

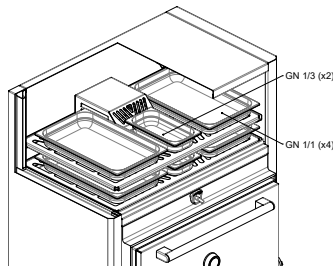

Residual temperatures of the heating rack in the top cabinet approximately 150°C, based on the oven working at 300°C.

## CUSTOMIZE

### DOOR COLOR



BLACK



RED



YELLOW



STAINLESS STEEL



BLUE

### EDITION



GOLD



BLACK



COPPER



TITANIUM



SILVER



WOOD\*

The Edition finishes are applied to the logos, door handle and the thermometer casing. \*Only on the door handle (logos and thermometer casing in silver)

## INSTALLATION GUIDELINES AND SAFETY STANDARDS

Clearances to construction/other appliances from oven	76 mm
Clearances of flammable materials from oven	300 mm
Clearance of workspace from front of the oven	1100 mm



It is recommended to use a lifting device to lift the oven and place on the countertop/cabinet. Consult oven instruction manual for further information.

Specifications and design are subject to change without notice.